

SJÖVIKSBACKEN 3

Planritning och Sektion

Lokal I

Plan 1 = 87 m²

Plan 2 = 20 m²

Total Yta: = 107 m²

Adress: Fredsborgsgatan 32

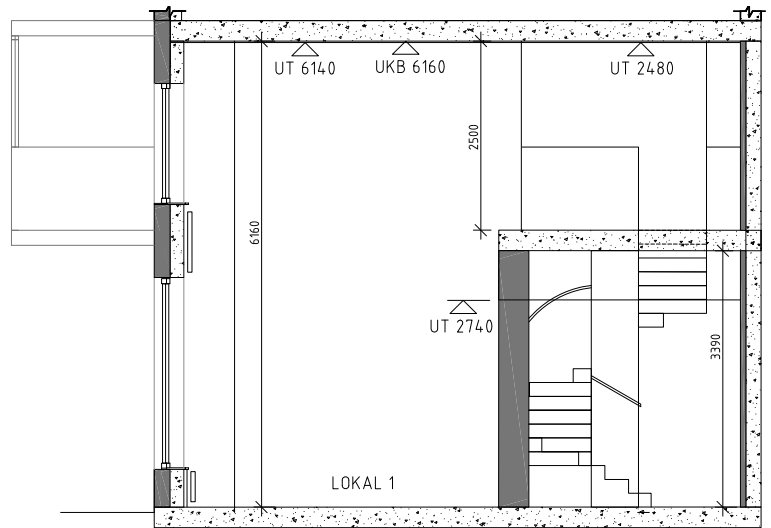
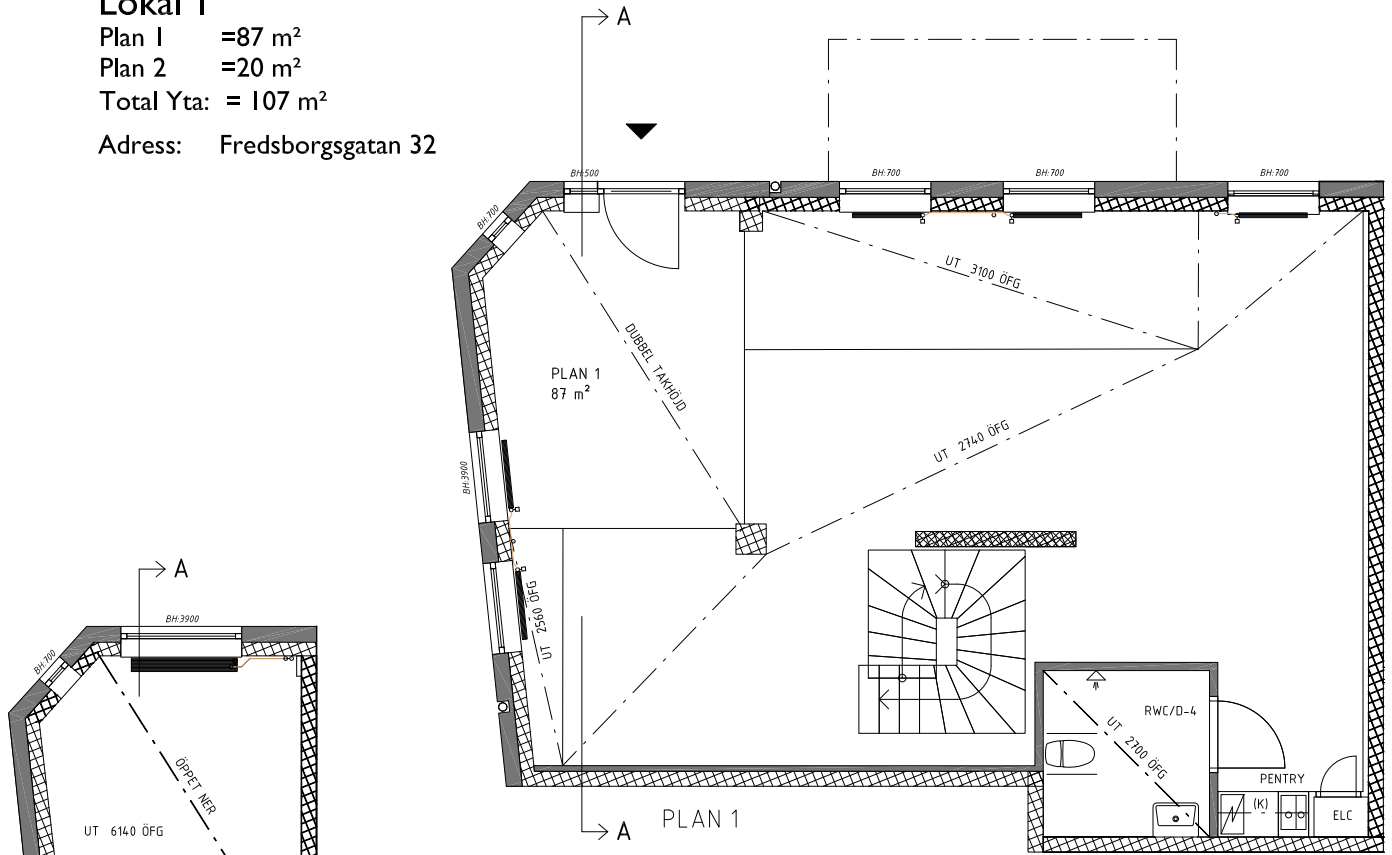

SEKTION A-A

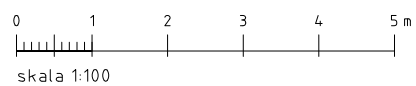
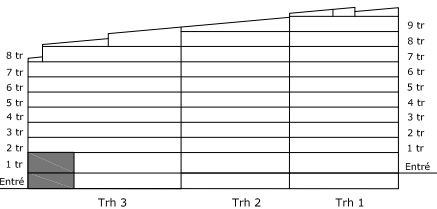
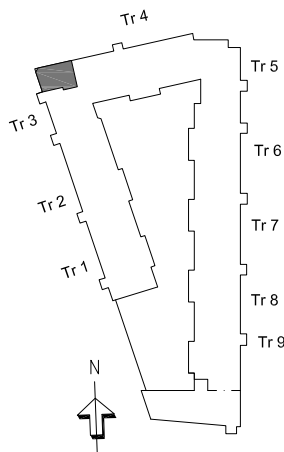
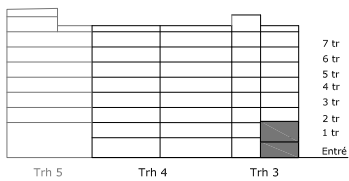

RÄTT TILL ÄNDRINGAR FÖRBEHÅLLS



2017-04-18

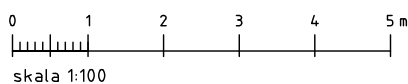
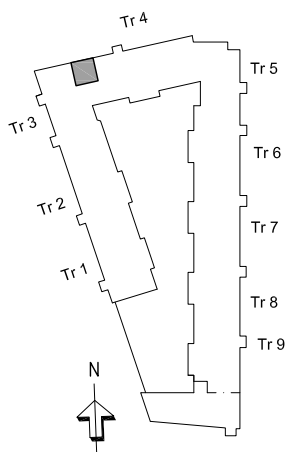
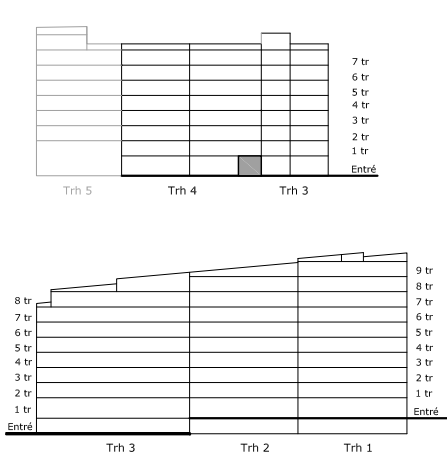
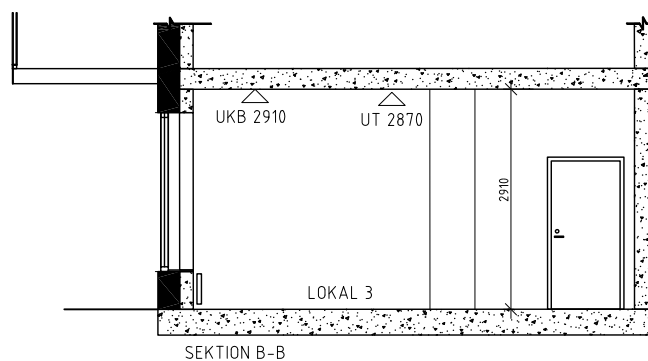
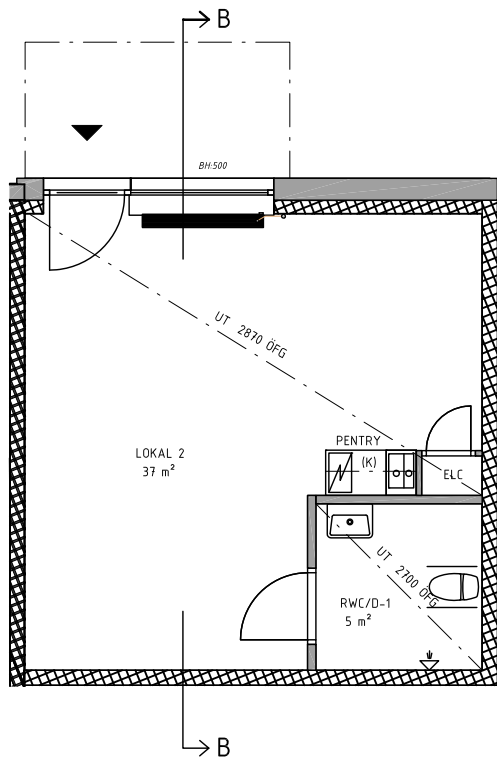

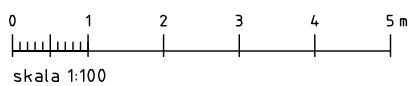
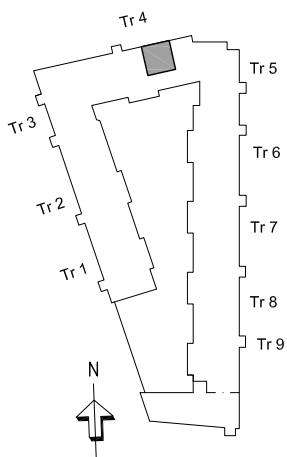
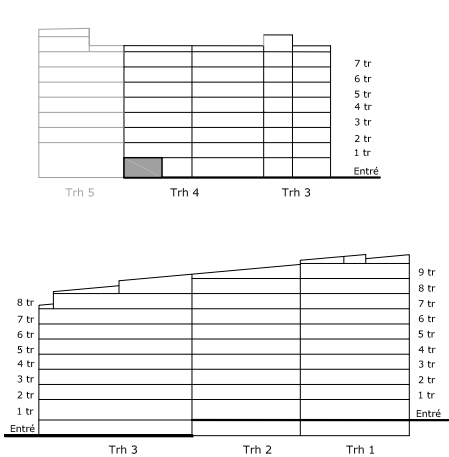
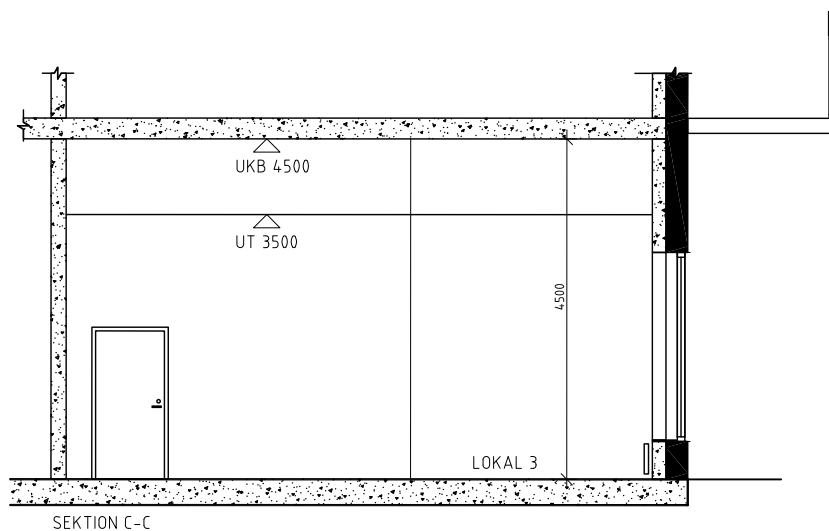
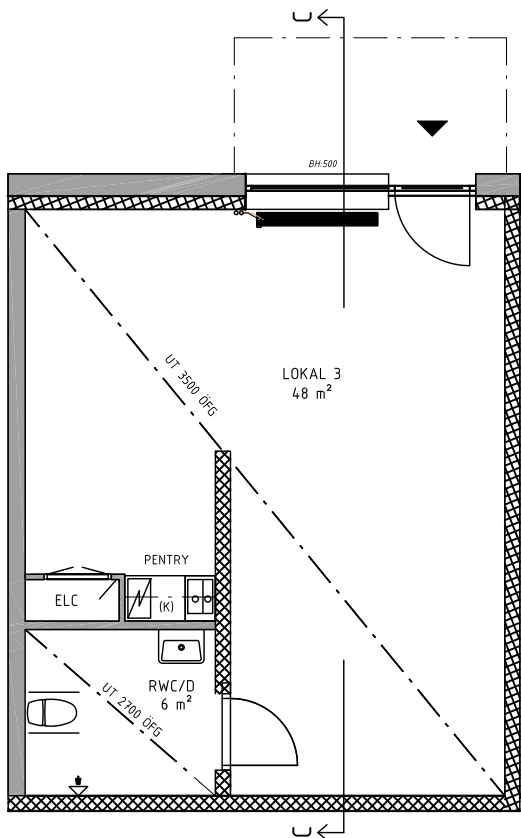

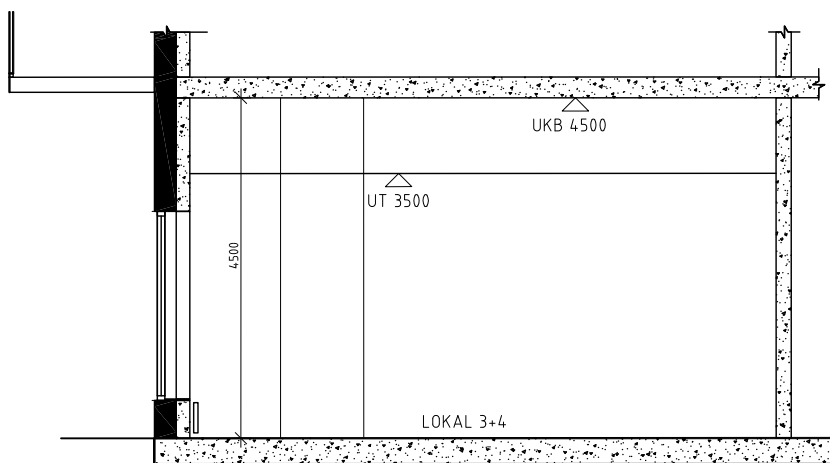
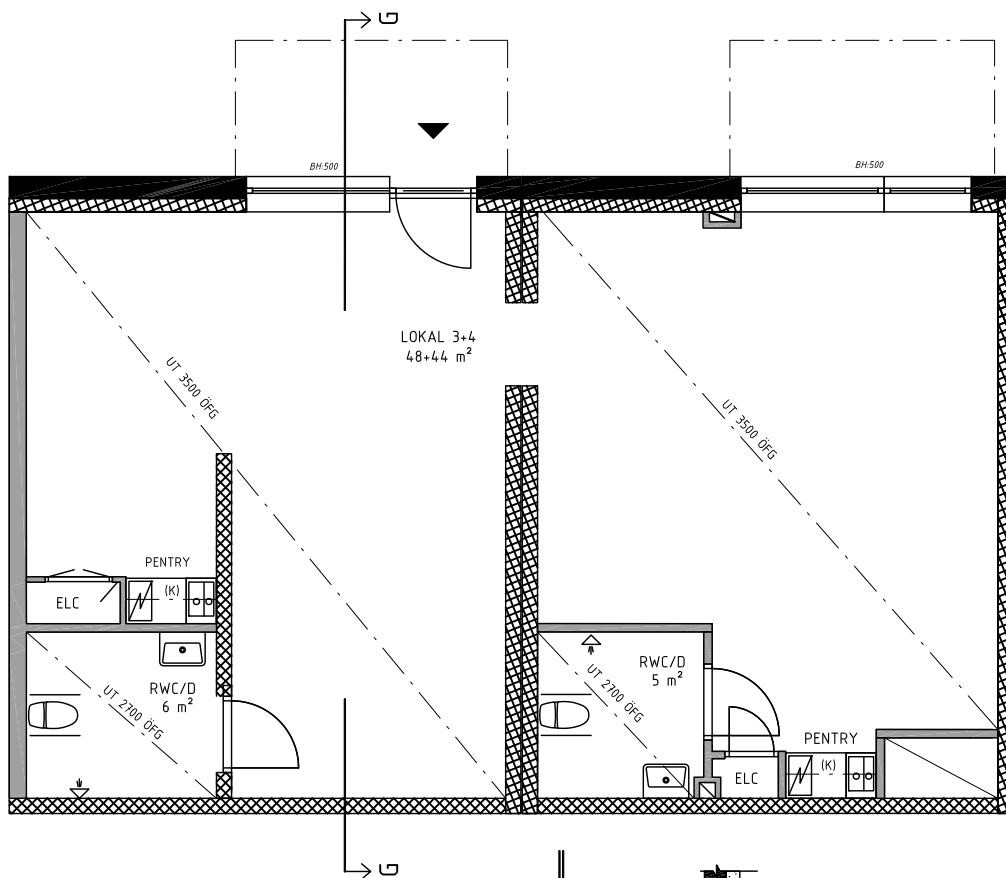

SEKTION G-G

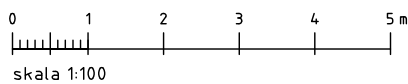
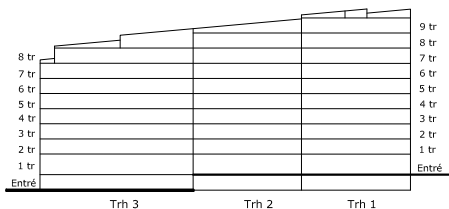
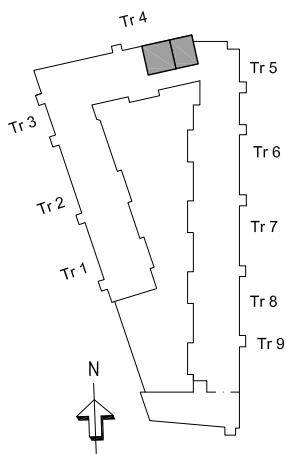
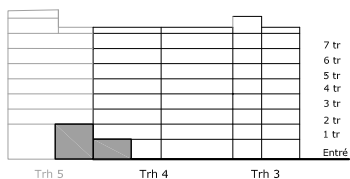

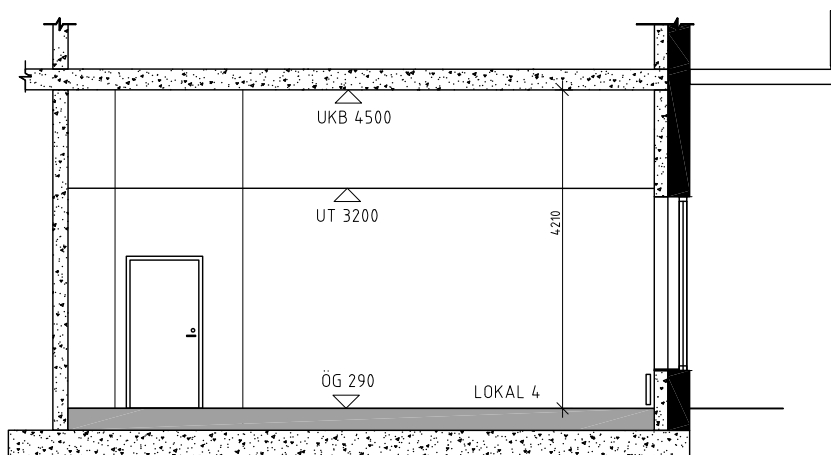
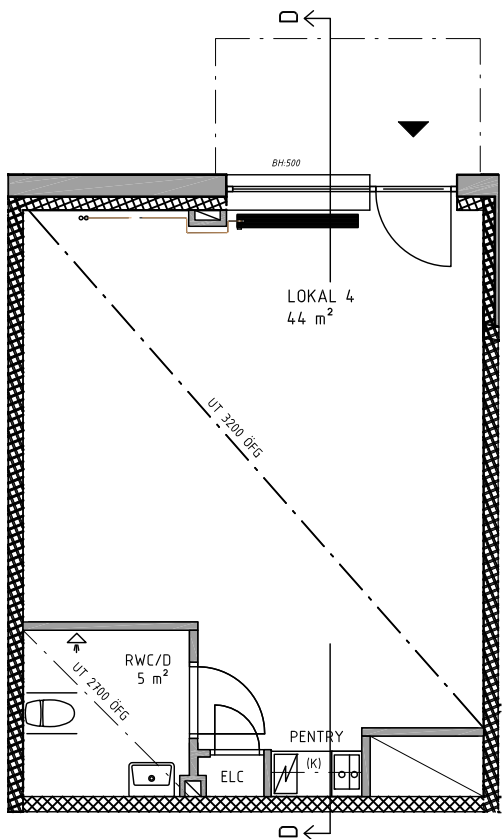

SEKTION D-D

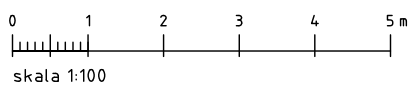
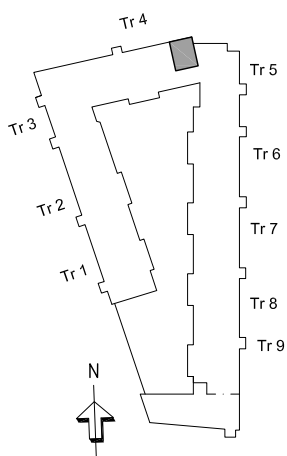
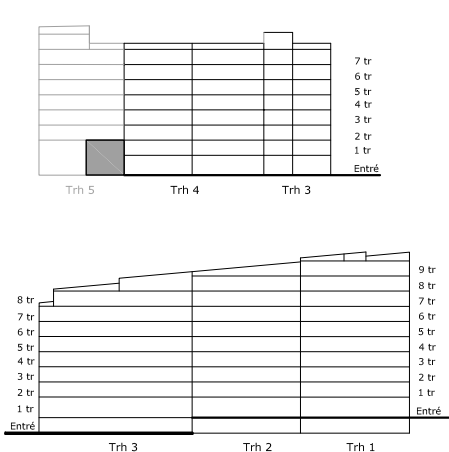

SJÖVIKSBACKEN 3

Planritning och Sektion

Lokal 5

Yta: 89 m²
 Address: Fredsborgsgatan 42

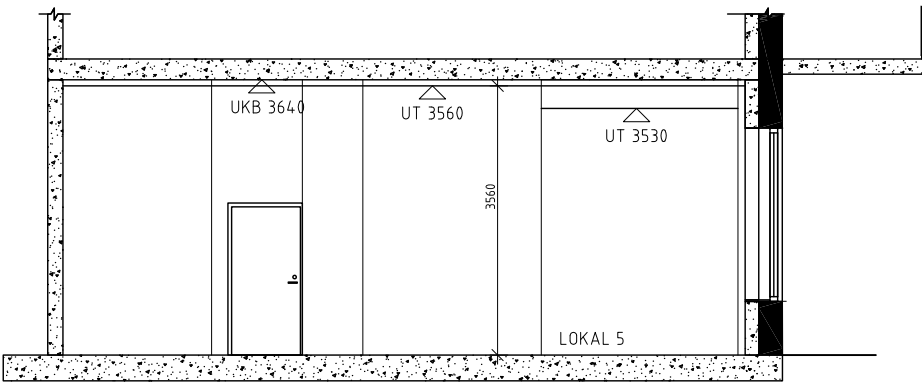
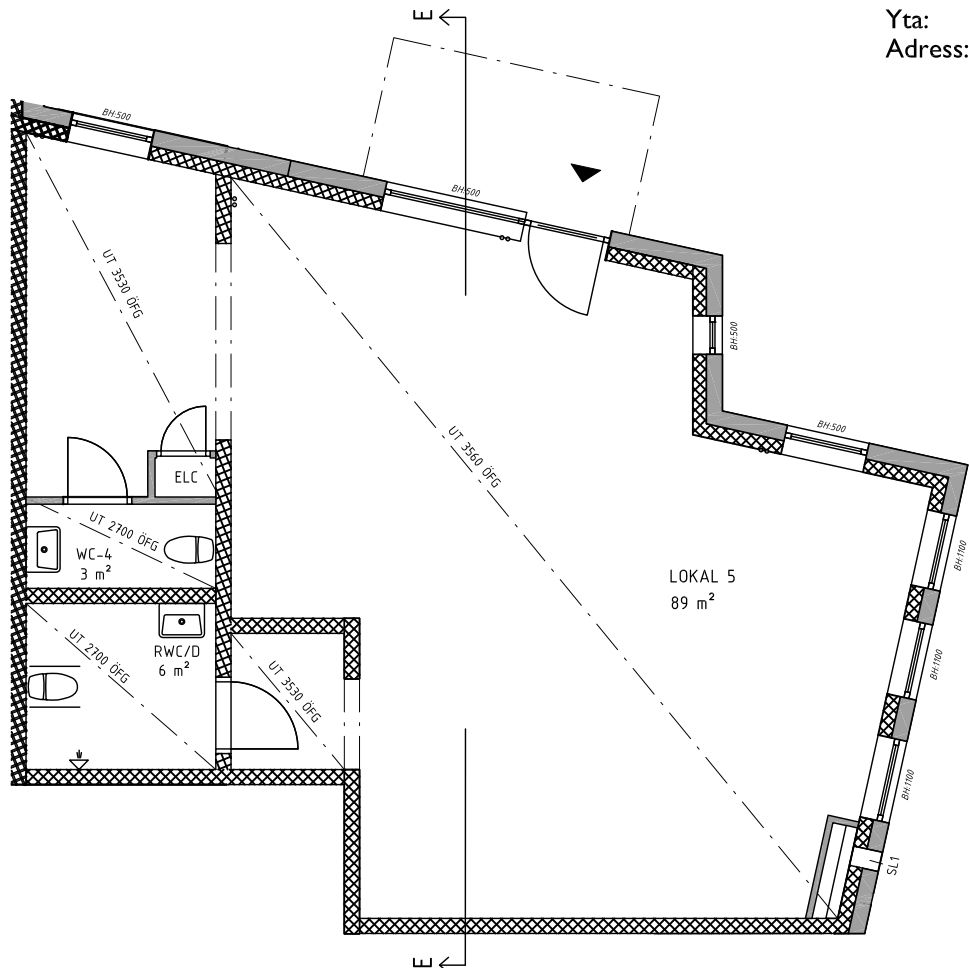

SEKTION E-E

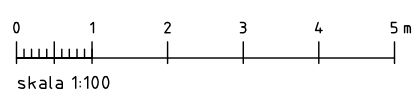
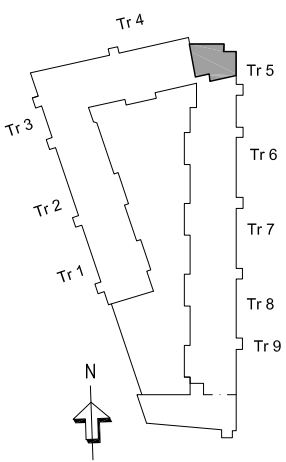
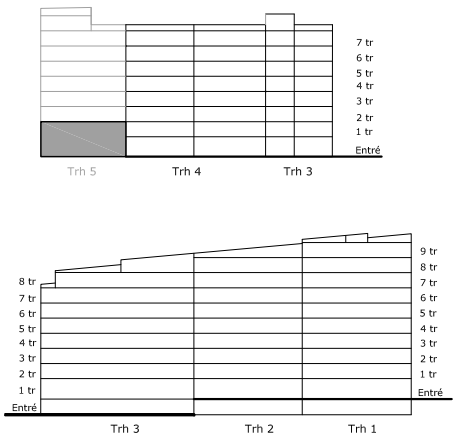

RÄTT TILL ÄNDRINGAR FÖRBEHÅLLS



2017-04-18

SJÖVIKSBACKEN 3

Planritning och Sektion

Lokal 6

Yta: 153 m²
 Address: Sjöviksbacken 22 A

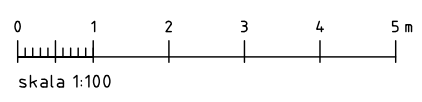
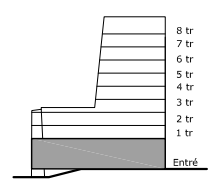
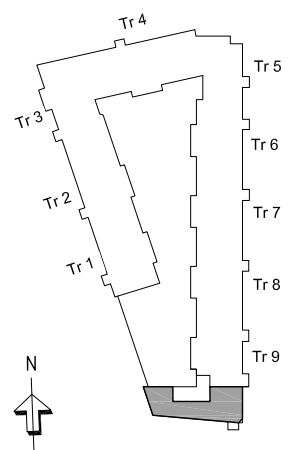
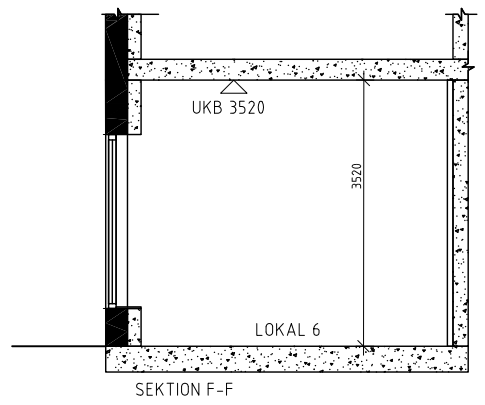
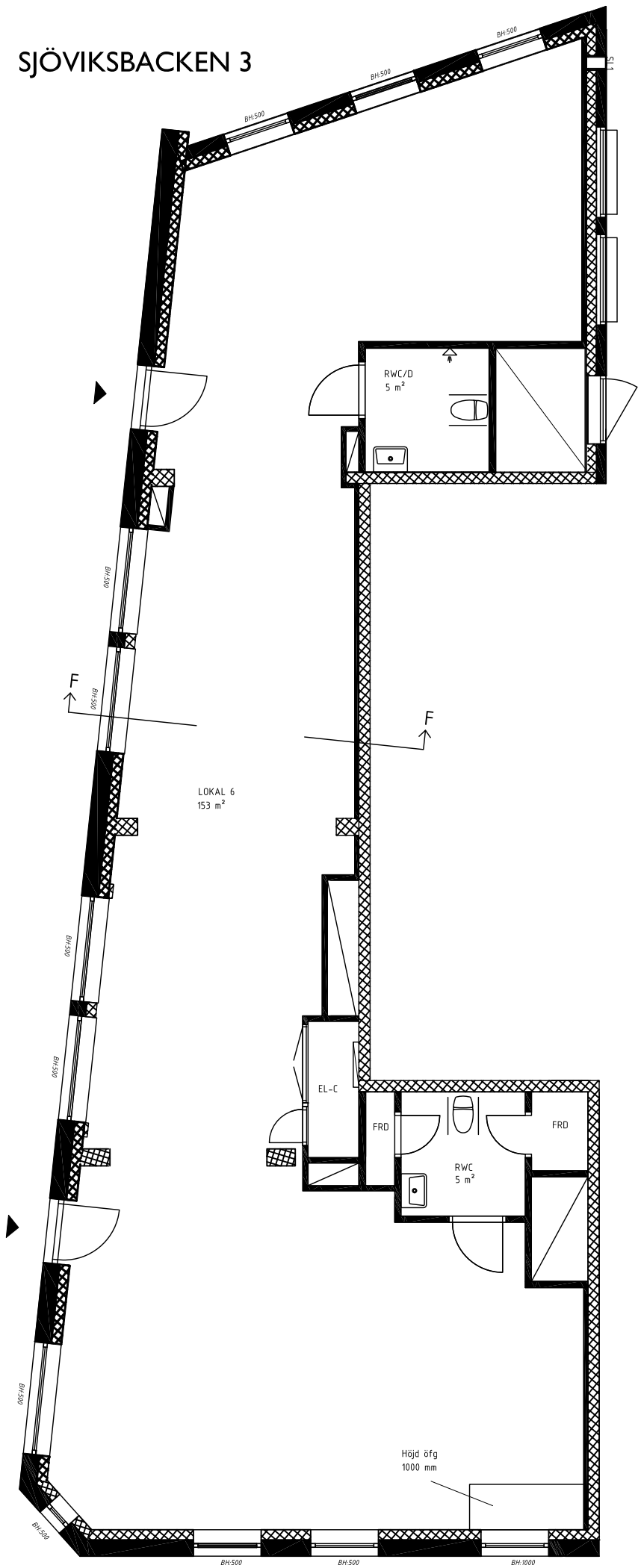

RÄTT TILL ÄNDRINGAR FÖRBEHÅLLS

2017-04-18